

MUSE series

User's manual

SPECIFICATIONS

Thank you for purchasing the MUSE series loudspeaker system. MUSE series is two-wayfull range loudspeaker.Designed with European customize bass speaker, The HF is 1"throat diameter compression driver. MUSE series loudspeaker have a very flat frequency response in it working frequency range,high frequency and low frequency have a smooth connection by the optimal X-over point, it's very good for near field performance.MUSE series can output a very deep and warm low frequency when install close to the wall,becauseof special designed of the vent in cabinet. The SUB series subwoofer used the 15 inch European customize woofer which is specially used for MUSE series full frequency loudspeaker.SUB series subwoofer can output very deep and warm sound when it near the wall because of special designed of the vent in cabinet.

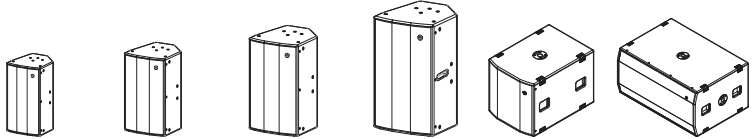

Model	MUSE 8	MUSE10	MUSE12	MUSE15	SUB115	SUB215
Program power	400W	600W	750W	800W	800W	1600W
Nominal impedance	8 Ω	8 Ω	8 Ω	8 Ω	8 Ω	4Ω
Frequency response(-10dB)	50Hz~20kHz	47Hz~20kHz	42Hz~20kHz	40Hz~20kHz	35Hz~2kHz	35Hz~2kHz
Sensitivity	93dB/1W/1m	96dB/1W/1m	98dB/1W/1m	98dB/1W/1m	98dB/1W/1m	98dB/1W/1m
Maximum SPL (pink noise, 1W, 1m)	> 119dB	> 124dB	> 127dB	> 127dB	> 127dB	> 130dB
Diffusion Angle:	90°x90°	90°x60°	90°x60°	90°x60°		
LF section (Ferrite driver)	1x 8" (V.C:1.8")	1x 10" (V.C:1.8")	1x 12" (V.C:2")	1x 15" (V.C:2.5")	1x 15" (V.C:3")	2x 15" (V.C:3")
HF section (compression driver)	1x 1" Voice coil Ferrite		1x 1.4" Voice coil Ferrite		/	/
Connectors	2x NEUTRIK® Speakon NL4 ±1 INPUT/±2 LINK				2x NEUTRIK® Speakon NL4 NL4 (±1 INPUT/±2 LINK)	
Cabinet	CNC made birch multi-layer plywood sand texture and weather-resisting protection paint					
Hanging	20xM8 flying points			/	/	
Product Dimension(mm)	280x330x460	330x380x540	395x450x640	470x520x740	500x700x500	1000x700x500
Packaging Dimension(mm)	407x357x533	457x407x616	547x492x733	617x567x833	797x597x593	797x597x1093
N.W	11.9kg	14.8kg	20.3kg	26.9kg	33.2kg	59.3kg
G.W	14.5kg	18.8kg	26.6kg	34.7kg	41.2kg	68.8kg

All specifications are subject to change without notice.

INSTALLATION

MUSE Wiring :

- ±1, Full range/INPUT
- ±2, Sub/LINK
- NL4 Speakon plug

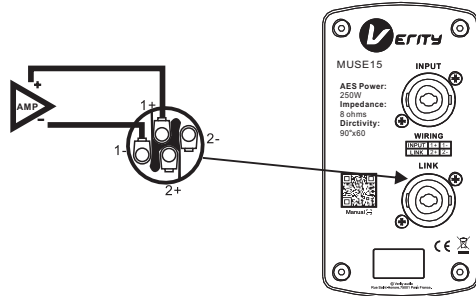

SUB Wiring :

- ±1, Full range/INPUT
- ±2, Sub/LINK
- NL4 Speakon plug

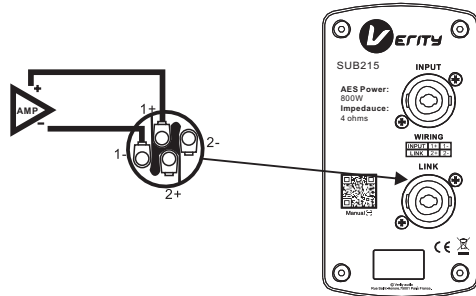

When sub-woofer is in the same place with MUSE, we suggest to use 4 wires, can save time and cable. Like the picture on the right.

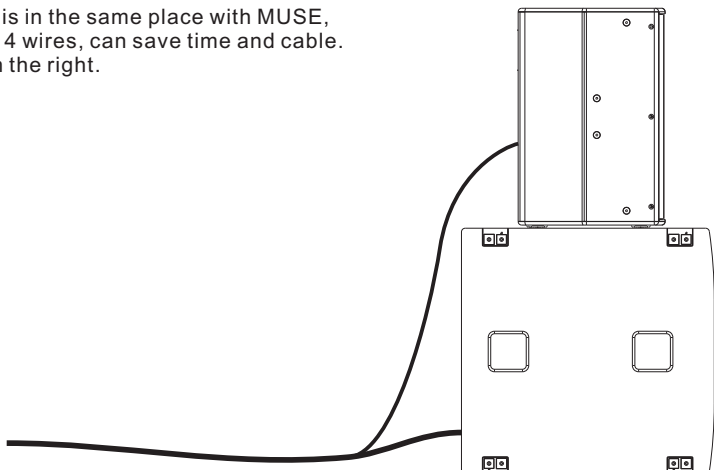

Hanging:

MUSE series loudspeaker has M8 flying points, you need to remove the screws of the flying points when need to hang the loudspeaker.



And must check if all the screws are screw in to the flying points after installation, if not it may cause air leakage and make sound worse.

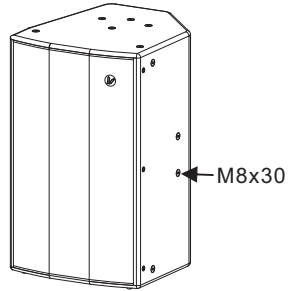

Angle adjustment:

①MUSE series loudspeaker have a rotatable horn, so you can adjust it by yourself when you need to change the angle.

Default angle:
Horizon 90°
Vertical 60°

②Logo Angle adjustment :
MUSE series loudspeaker have a rotatable Logo. Pull out the logo 3 to 6 mm gently and then rotate it.

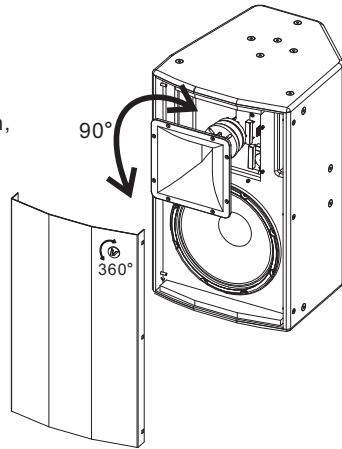

Accessories :

- ① With M20 inner thread aluminum chassis seat
- ② Loudspeaker support rod with M20 thread
- ③ U-shaped hanging parts, flexible angle adjustment, 15° and 30° increments per scale.

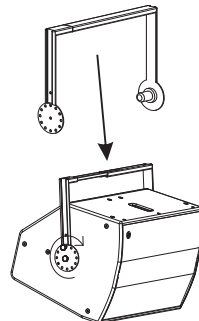
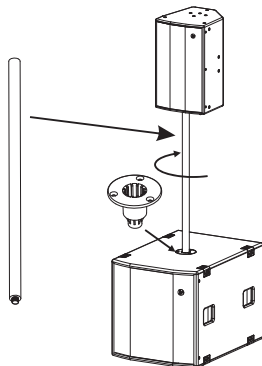

INSTALLATION

Install loudspeaker with bracket:

Choose the right flying points and install with bracket*.

* a safety security stell wire is necessary!

There is no bracket in the package, please purchase by yourself.

To achieve the best low frequency response, should assemble the cabinet close to the corner. The back hole of the cabinet should be keep 20-30cm from the wall.



Install loudspeaker with eye bolt:

Choosing the right flying points and install with eye bolt.

When installation try your best to make cabinet close to the wall 20cm to 30cm, that can improve the bass performance.



M8X30 eye bolt

There is no eye bolt (M8x30mm) in the package, please purchase by yourself.



To achieve the best low frequency performance, should assemble the cabinet close to the corner. The back hole of the cabinet should be keep 20-30cm from the wall.

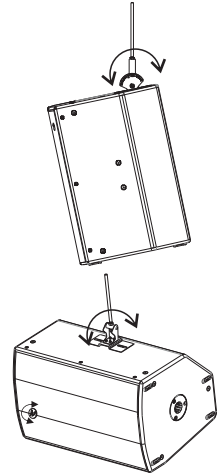

A safety security stell wire is necessary !
Adjust the angle

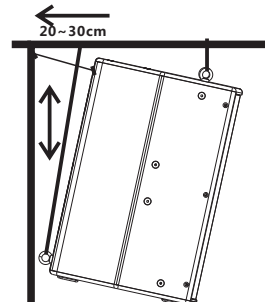
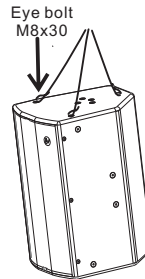

Verity Audio reserves the right to make any changes to the product specifications without prior notice.
Final specifications to be found in the user manual.

